

CAME 
KMS

MORE THAN
50+
YEARS



DNB & DNC

**Digital Notice Board solutions:
Simple, quick and effective
communication with your residents**





DIGITAL NOTICE BOARDS: THE MOST EFFECTIVE WAY TO COMMUNICATE IMPORTANT INFORMATION TO YOUR RESIDENTS

CAME KMS digital notice board solutions are designed to provide customers with a simple, flexible, and extremely powerful way to communicate information with residents efficiently using a digital platform managed in the cloud.

Our DNBs can provide you with:

- » A highly effective platform to create engaging digital messages to communicate directly with your residents, such as ongoing repairs, maintenance or health and safety notices.
- » Budget-friendly electronic messaging service that can deliver a range of messages quickly and efficiently, that can be managed by multiple departments at once
- » An opportunity to reduce printing costs and provide an eco-friendly approach to communication
- » A communication team that no longer need to make costly and inefficient trips to site to deliver important messages, it can all be managed remotely.
- » A streamlined way of improving access to information for your tenants that can be scheduled with time management profiles to ensure effectively delivery
- » Advertising opportunities to market and promote to residents
- » They can be used in a range of areas, including lobby, reception, study hall, corridor, library or any other communal location
- » Support the communication needs of Accountable People within organisations as set out by the Building Safety Act 2022

Using **SimpleKey Web**, CAME KMS's user friendly access control cloud platform, users can create and manage the format, style and frequency of important messages they need residents to engage with.

- » Simple to use - no programming or design skills required,
- » Messages can be typed directly into our simple interface and created in seconds - you do not need to import any complicated files
- » Many common graphics formats including JPG and GIFs (still and animated) are supported
- » Can be configured as landscape or portrait
- » Options to use 4G connectivity, or to connect to your own broadband
- » Vandal resistant casings with toughened glass (DNB only)
- » **FREE Over the Air Updates.** Our dedicated UK development team are regularly improving and revising the features of the DNB system. Updates to options within the web interface are combined with over-the-air updates to installed DNB and DNC panels, all at no additional cost within your hosting package

4G OR IP CONNECTIVITY

USE YOUR OWN BROADBAND OR CHOOSE THE SIMPLICITY OF 4G

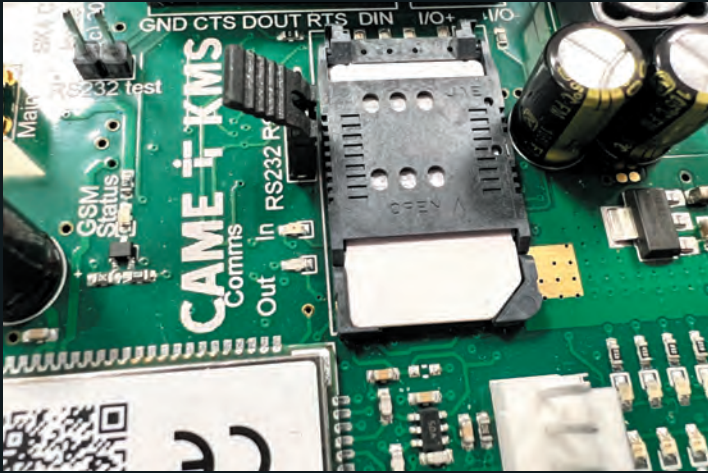

Choose from either 4G or IP connectivity options - the choice is yours.

Our 4G data SIM operates as the communication gateway for the SimpleKey Web system and is designed specifically for locations without a local network connection. SIM data is unlimited – add, edit and delete as many messages as you require without the worry of data plans.

Alternatively, if your housing stock already has broadband, simply latch onto your network, and utilise your local internet connection.

VANDAL RESISTANT

HIGH SECURITY CASING WITH DUAL LOCK SYSTEM



Finished in powder coated steel with a secure dual locking mechanism, this vandal resistant design is tailored specifically for locations subject to heavy usage or abuse.

Integrated cable channelling keeps the Digital Notice Board vandal-proof while allowing wires to travel to other areas securely.



TOUGHENED GLASS

VANDAL RESISTANT SCREEN

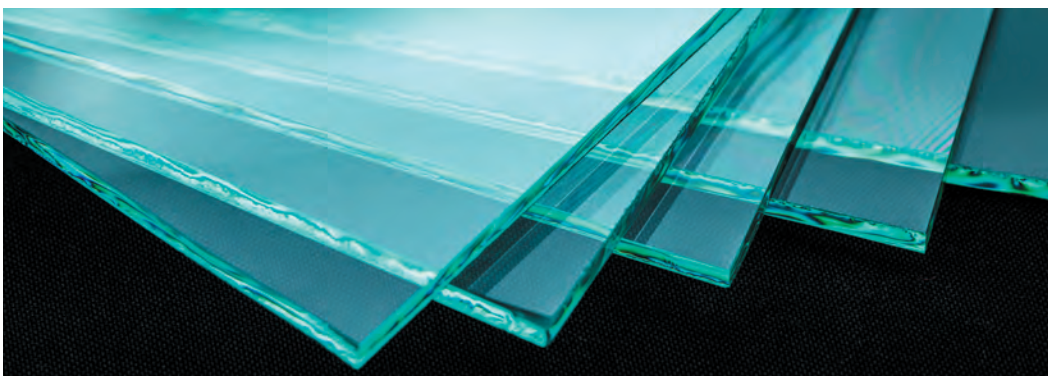

3mm thick reinforced glass shields the digital display and system components from harm caused by external forces.

STEEL ENCLOSURE

DESIGNED TO WITHSTAND HEAVY USAGE



Digital Notice Controllers are housed in robust casings finished in powder coated steel, with punch outs for mounting and cabling flexibility.

Enclosures are water and shock resistant due to the materials used for sealing and structural reinforcement.



▲ POWDER COATED STEEL ENCLOSURE

High security casing with punch outs for mounting and inserting cables.

▲ SECURITY LOCK

The enclosure locks securely to prevent unauthorised access.

USE DISPLAYS OF ANY SIZE

HDMI OUTPUT FOR YOUR OWN SCREENS



For complete flexibility the Digital Notice Controller can be attached to any display with an HDMI input.

The DNC software adapts to the screen size and ratio delivering messages created in SimpleKey Web.

You can mix and match screens, integrating DNB and DNC solutions across your properties.

This flexible solution allows you to deliver multiple messages and bridge the communication gaps between employees and residents.

CREATING YOUR MESSAGE



QUICK AND EASY TO SETUP USING SIMPLEKEY WEB

Using the cloud-based SimpleKey Web portal, you can deliver real time updates for clients, residents and staff by creating and managing notice messages. The user-friendly interface makes it simple to edit, update, and create notices that may be scheduled or published immediately.

CUSTOMISE YOUR MESSAGE

Choose from an ample selection of fonts and colours to suit your requirements.

SCHEDULE

Send your message to screen immediately or schedule it for display at a later time.

CREATE NOTICE MESSAGE

Message Name

Transition Speed Override

Permanently Show Message

Full Screen Message

Message Title Colour

Message Title Font

Message Title

Message Text Colour

Message Font

Message

Display Now
 Schedule

JPEG / PNG / GIF / WEBP Image
 PDF / Word / Excel / PowerPoint Document
 PowerPoint Animation

1. Recommended resolution: more than 800 * 600.
2. Recommended file size: less than 3MB.
3. Upload the JPEG / PNG / GIF / WEBP image here:
Choose a file or drop it here...

4. Preview:

FULL SCREEN OVERRIDE

If you wish to maximise your visual impact you can select full screen mode for selected messages, videos and animations.

MEDIA TYPES

Choose from a selection of the most widely used graphic types such as JPG and PNG through to PDFs, Word files, and even Powerpoint animations.



SCHEDULING YOUR MESSAGE



PROGRAM YOUR MESSAGES IN ONE SIMPLE PAGE

Easily control the timing and frequency of your messages, and alter other important aspects all together in one place.

BEGIN DATE

Schedule messages ahead of time.

EXPIRY DATE

Remove time sensitive notices when out of date.

FREQUENCY

Schedule the frequency of your message, over a period of weeks or months. For example, to always display the correct waste collection based on the week.

The screenshot shows a web-based scheduling interface. On the left, a sidebar lists various fields: Schedule, Begin Date, Expiry Date, Frequency, Day of Week, Number of Days to Display, New Picture, and New Image. The main content area is titled 'Schedule' and includes a 'Display Now' / 'Schedule' toggle, input fields for 'Begin Date' (12/17/2024) and 'Expiry Date' (12/12/2024), a 'Frequency' dropdown set to 'Every' with a 'Frequency' field set to 'Weeks', and a 'Day of Week' dropdown set to 'Monday'. Below these are fields for 'Number of Days to Display' and 'New Picture' (with options for JPEG/PNG/GIF/WEBP Image, PDF/Word/Excel/PowerPoint Document, and PowerPoint Animation). A 'New Image' section includes a 'Browse' button and a 'Preview' section. At the bottom right are 'CREATE' and 'CANCEL' buttons.

DAY OF WEEK

Select which days of the week you would like your message to be displayed, to keep information relevant to residents.

NUMBER OF DAYS TO DISPLAY

Set the number of days that your message will display once the schedule has started.



CUSTOM BACKGROUND, TEXT & GRAPHICS



EASILY ADD YOUR OWN IMAGES TO YOUR NOTICES

It's easy to customise your notices by selecting your own pictures. Text may also be easily re-coloured where appropriate, and there are a choice of different fonts. The built-in design tools ensure that whatever the message, users without design experience can publish updates with a consistent look and feel across all their notice boards.



EMBED YOUR CORPORATE IDENTITY



DISPLAY A UNIFIED LOOK ACROSS ALL OF YOUR NOTICE BOARDS

CAME KMS can pre-program your suite of DNBs and DNCs to default to a customised theme, meaning that it does not matter who creates your messages, they will always match, thus protecting your corporate identity. Contact customer support for full details.

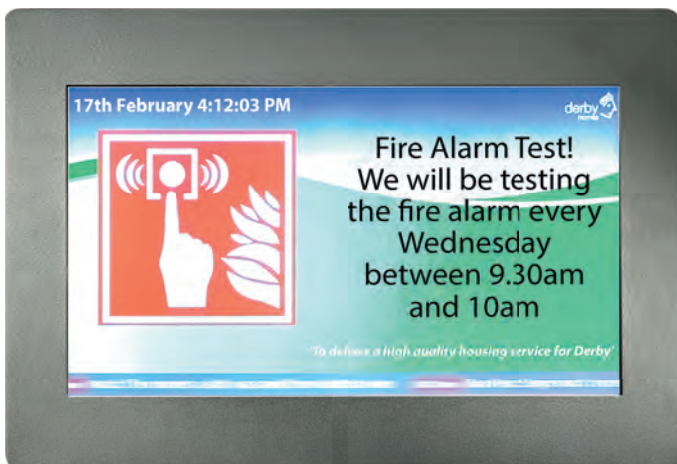

SIMPLEKEY FILE TYPES

WORKING WITH DIFFERENT GRAPHIC FORMATS



SimpleKey Web's industry leading interface is fully compatible with all leading file types allowing you to easily customise your messages.

IMAGES



All common graphic filetypes can be loaded into the SimpleKey 4 web interface and used on your messages.

PDF & OFFICE CONVERSIONS (SINGLE PAGE)



SimpleKey Web will convert PDFs and office files into images which can be used in your messages. *Please note: only the first page will be converted.*

POWERPOINT ANIMATIONS



You can import PowerPoint slideshows by converting them to animated GIFs. By playing these in full screen mode you can fully customise the appearance of the screen.

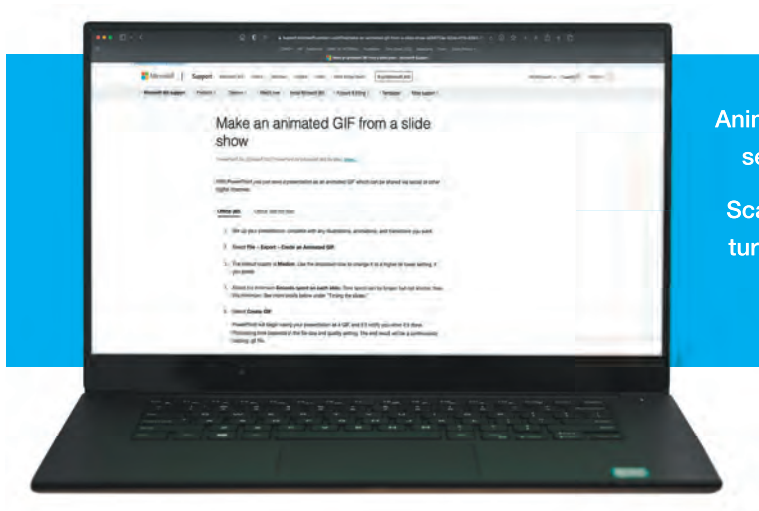

Animated GIFs can run up to 180 seconds with a 20MB file limit.

Scan here for full instructions to turn your PowerPoint slideshow into an animated GIF.



MONITOR & PREVIEW

EVERYTHING IN ONE PLACE WITH SIMPLEKEY WEB



Create, preview, and monitor your notice board messages and announcements, all in one place.

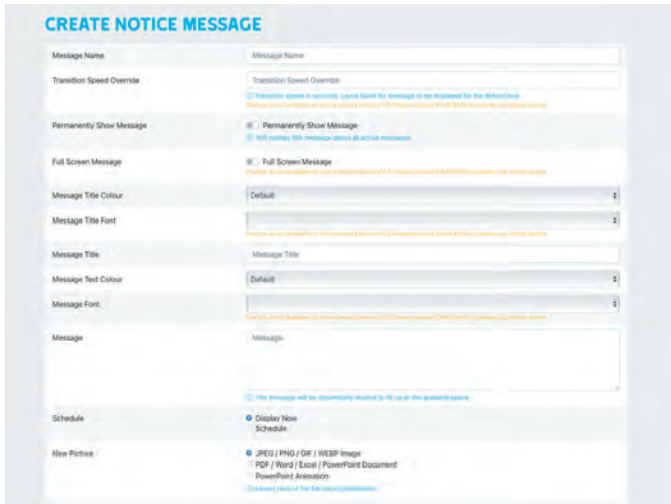

▲ CREATING MESSAGES

Creating new messages only takes a few minutes with the easy to navigate interface.



▲ MONITOR MESSAGES

Monitoring messages and announcements is easy using SimpleKey Web.



▲ PREVIEW MESSAGES

You can easily preview your messages before making them live to ensure they are correct.

TENANT SATISFACTION MEASURES



HELPING YOU TO BE COMPLIANT WITH THE LATEST GOVERNMENT CHARTER

Social housing landlords have been subject to new levels of tenant accountability since April 2023, following the implementation of new rules by the UK Government. Tenant perception surveys are an important part of helping to fulfil these requirements and CAME KMS's Digital Notice Boards are the perfect way to deliver these messages. Links to the surveys can be easily added to on screen graphics, allowing tenants to scan and complete on their smartphone at their leisure. This ensures their answers remain private and confidential and means they don't have to physically interact with the screen.

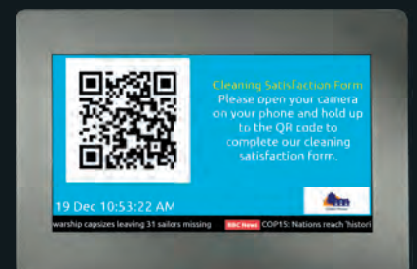

DAY & NIGHT

OPTIMUM VIEWING COMFORT, WHATEVER THE HOUR

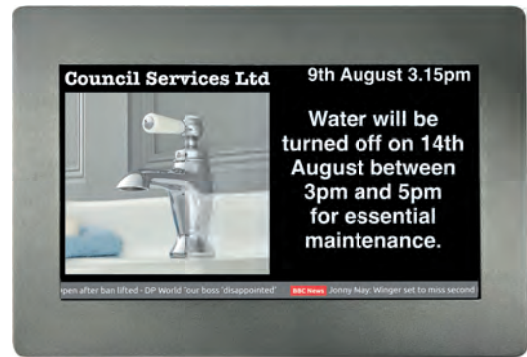
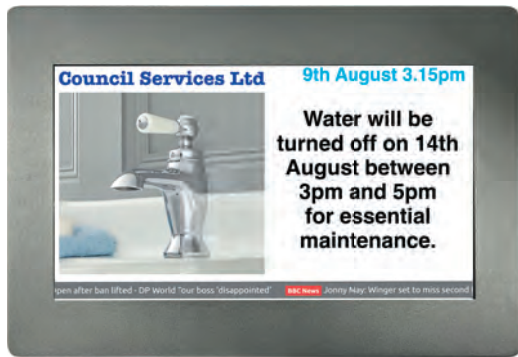
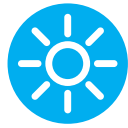

Pre-program day and night viewing routines. Set a time for the display to change from day to night mode. In night mode, your display theme will feature darker colours, making it easier and more comfortable for people to read.

PORTRAIT MODE

ROTATE YOUR SCREENS TO BEST FIT THE ENVIRONMENT



Some settings call for a different perspective, and that's where portrait mode comes in. Select between landscape and portrait modes when you are conducting your installation setup to ensure the screen displays correctly.

By default messages are set up horizontally, however the intuitive software will resize messages in to display in portrait mode once display setup has been chosen.



NEWSFEEDS

GIVE YOUR NOTICE A DYNAMIC LOOK WITH A SCROLLING NEWSFEED



Bring your digital notice board to life by adding scrolling news stories so residents can stay up to speed on what's going on outside their community.

Your digital notice board will display live updates from the BBC RSS feed. This can also be altered to a different RSS source if you would prefer.

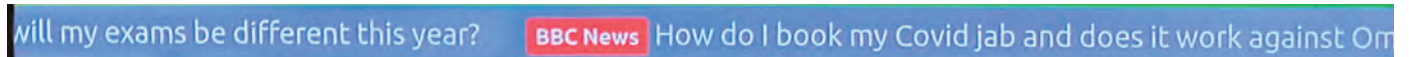



Digital notice board solution for residential settings and apartment blocks

The CAME KMS Digital Notice Board works in conjunction with the SimpleKey Web access control software, to provide residents with up to date messaging and advice.

- Supplied as a standalone product or as part of an overall CAME KMS SimpleKey system.
- Compatible with most types of SimpleKey on site equipment whether existing or new.
- Administration is via the SimpleKey Web interface and is accessible from any internet enabled device.
- Vandal Resistant wall mounted 15" toughened glass screen.
- Text and Images can be uploaded to a single, group or to all notice boards.
- Supports JPEG, PNG, GIF and WEBP image types
- Optional RSS feed giving live news updates.
- Robust British design, specifically for UK housing providers.

Dimensions (mm)

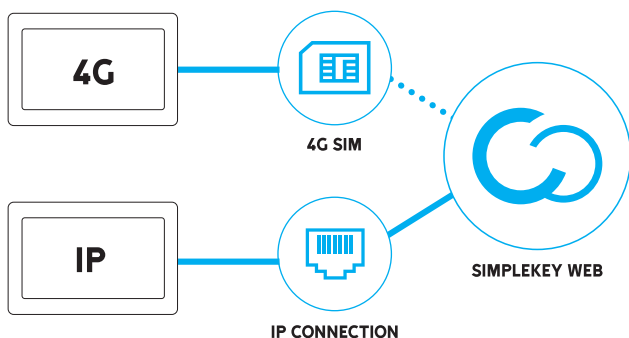
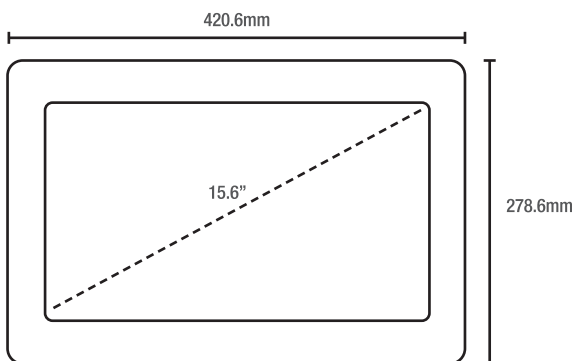

Technical characteristics

MODELS	DNB-IP	DNB-4G
Power input	12-14v DC	12-14v DC
Overall power consumption	≤25W	≤25W
Connectivity	Broadband	4G
Outputs	CAT5/6 network cable out to the client's broadband router or switch	4G antenna cable out to external elevation with mounted antenna
Case Material	Powered Coated Steel	Powered Coated Steel
Case Colour	Matte Black	Matte Black
Glass	Toughened Glass	Toughened Glass
Dimensions	420.6mm x 278.6mm x 49.5mm	420.6mm x 278.6mm x 49.5mm
Screen size	15.6"	15.6"
Max resolution	1920 x 1080	1920 x 1080
Display Area	344mm x 193mm	344mm x 193mm
Viewing Angle	89/89/89/89	89/89/89/89
Colour Brightness	16.7M	16.7M
Response time	6.5ms	6.5ms
Contrast Ratio	1500:1	1500:1
Brightness	250cd/m ²	250cd/m ²
Aspect Ratio	16:9	16:9
HDMI	X1	X1
Storage Temp (°C)	(-20 – 60)	(-20 – 60)
Operating temperature (°C)	(0 – 40)	(0 – 40)
Storage/Working Humidity	(10 – 90%)	(10 – 90%)
Display Fixings	9x fixings holes	9x fixings holes
Security	2x Barrel type locks, 1 either side	2x Barrel type locks, 1 either side
Cable Entry	Rear 40x40 cut out. 2x 20mm 'knockouts' for galvanised tube entry.	Rear 40x40 cut out. 2x 20mm 'knockouts' for galvanised tube entry.
IP rating	IP30	IP30
IK Rating	IK07	IK07

DIGITAL NOTICE BOARD KIT SELECTOR

All kits supplied with Electronic Notice Board, steel enclosure, 12V PSU, power cable, security keys and accessories and stickers pack. [Simply choose the selectable items listed in the chart below and follow the line across for your kit code.](#)



Notice Board	Power Cable	Keys	Accessories	Communications	Kit Code
--------------	-------------	------	-------------	----------------	----------



KIT CONTENTS

Digital Notice Board

- Electronic Notice Board in Steel Enclosure
- External 12V power adapter
- Multi Comms Module & Antenna (4G version only)
- SIM Card (4G version only)
- Security keys
- Set of accessories and stickers
- Full Instruction Manual and Setup Guide

DIGITAL NOTICE BOARD - THE FULL RANGE



Code	Description
Digital Notice Board Kit Items	
	Electronic Notice Board in Steel Enclosure with 12V PSU With built in IP Communications module
	Electronic Notice Board in Steel Enclosure with 12V PSU With built in 4G Communications module and aerial
	Power Cable





Digital notice board controller for residential settings and apartment blocks, for connecting to your own screen

The CAME KMS Digital Notice Board Controller works in conjunction with the SimpleKey Web access control software, to provide residents with up to date messaging and advice. As the controller can work with any external screen (not supplied) using a HDMI or VGA connector, the display can be as large as required for maximum visibility and impact.

- Supplied as a standalone product or as part of an overall CAME KMS SimpleKey system.
- Compatible with most types of SimpleKey on site equipment whether existing or new.
- Administration is via the SimpleKey Web interface and is accessible from any internet enabled device.
- Text and Images can be uploaded to a single, group or to all notice boards.
- Supports JPEG, PNG, GIF and WEBP image types
- Optional RSS feed giving live news updates.
- Robust British design, specifically for UK housing providers.

Dimensions (mm)

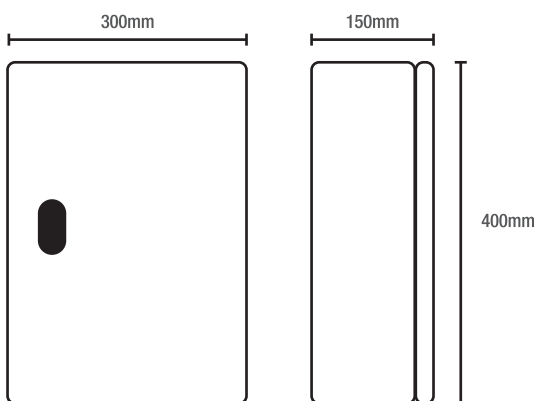

PLEASE NOTE: One HDMI output is provided with the digital notice controller. Additional HDMI splitters can be used but this is not the responsibility of the manufacturer (CAME KMS).

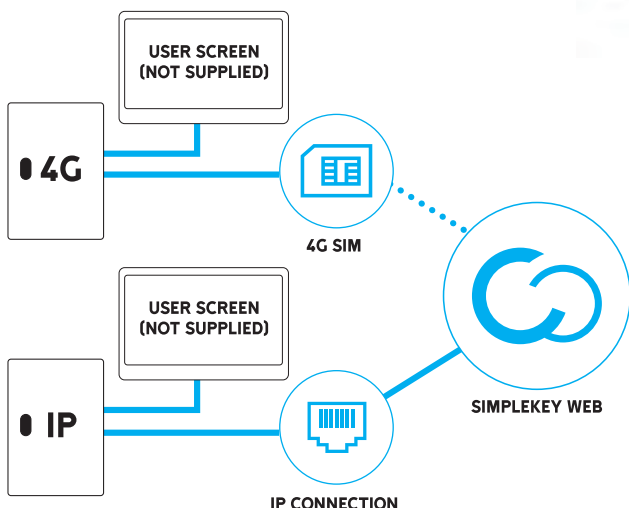

Technical characteristics

MODELS	DNC-IP	DNC-4G
Power input	12-14v DC	12-14v DC
Overall power consumption	≤25W	≤25W
Connectivity	Broadband	4G
Outputs	CAT5/6 network cable out to the client's broadband router or switch	4G antenna cable out to external elevation with mounted antenna
Case Material	Powered Coated Steel	Powered Coated Steel
Dimensions	400mm x 300mm x 150mm	400mm x 300mm x 150mm
Max resolution	1920 x 1080	1920 x 1080
Colour Brightness	16.7M	16.7M
Response time	6.5ms	6.5ms
Contrast Ratio	1500:1	1500:1
Brightness	250cd/m ²	250cd/m ²
Aspect Ratio	16:9	16:9
HDMI	X1	X1
Storage Temp (°C)	(-20 – 60)	(-20 – 60)
Operating temperature (°C)	(0 – 40)	(0 – 40)
Storage/Working Humidity	(10 – 90%)	(10 – 90%)
Fixings	4x fixing holes	4x fixing holes
Security	1x locks, on front. 2 x keys provided.	1x locks, on front. 2 x keys provided.
Cable Entry	Removable cable gland plate	Removable cable gland plate
IP rating	IP66	IP66

DIGITAL NOTICE CONTROLLER KIT SELECTOR

All kits supplied with steel enclosure, built in power adaptor, security keys and accessories and stickers pack. [Simply choose the selectable items listed in the chart below and follow the line across for your kit code.](#)



Notice Board	Keys	Accessories	Communications	Kit Code
--------------	------	-------------	----------------	----------



KIT CONTENTS

Digital Notice Board Controller

- Steel Enclosure with Hinged Door
- Built-in power adapter
- Multi Comms Module & Antenna (4G version only)
- SIM Card (4G version only)
- Security keys x 2
- Set of accessories and stickers
- Full Instruction Manual and Setup Guide

DIGITAL NOTICE CONTROLLER – THE FULL RANGE



Code	Description
------	-------------

Digital Notice Board Kit Items

	Electronic Notice Board Controller in Steel Enclosure with 12V PSU With built in IP Communications module
--	--



	Electronic Notice Board Controller in Steel Enclosure with 12V PSU With built in 4G Communications module and aerial
--	---



CAME KMS

A2 Glory Park,
Glory Park Avenue,
Wooburn Avenue
HP10 0DF

Tel: 01494 531099



© CAME SPA - DNBCAT0125 - 2025 - EN UK
CAME RESERVES THE RIGHT TO MAKE ANY CHANGES TO THIS DOCUMENT AT ANY TIME.
YOU MAY NOT EVEN PARTIALLY REPRODUCE THIS DOCUMENT.



CAME S.p.A.
has the following Quality, Environmental
and Safety certifications:
ISO 9001
ISO 14001
ISO 45001